

SC94 PUSH SIDE (TOP JAMB) DROP PLATE PERMITS 180° MAXIMUM OPENING

PUSH SIDE MOUNT ON: SC90-18 DROP PLATE

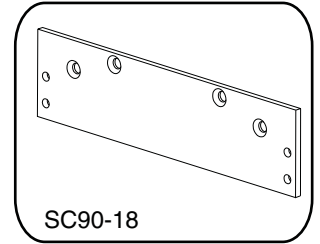
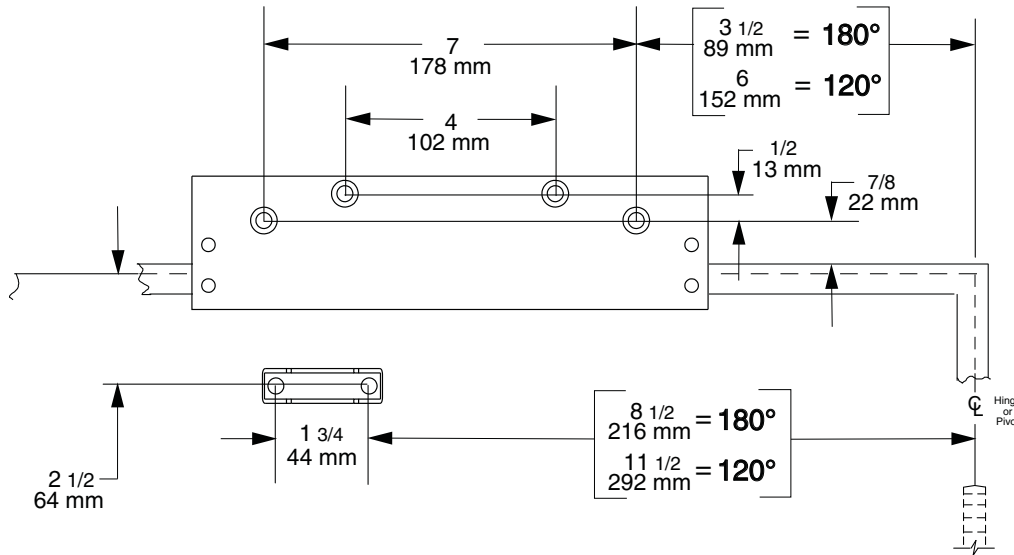

- General Notes:
1. Latch speed faces toward from the hinge edge.
 2. Use shorter machine screws to attach cylinder to drop plate.

RIGHT HAND DOOR ILLUSTRATED. Same dimensions apply for Left Hand Door measured from hinge side.

SC94 PUSH SIDE (PA DOOR MOUNT) DROP PLATE PERMITS 180° MAX. OPENING, BUTT SIZE 5x5 MAX.

PUSH SIDE MOUNT ON: SC90-18PA DROP PLATE

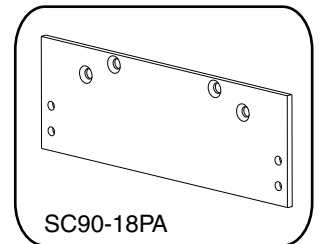
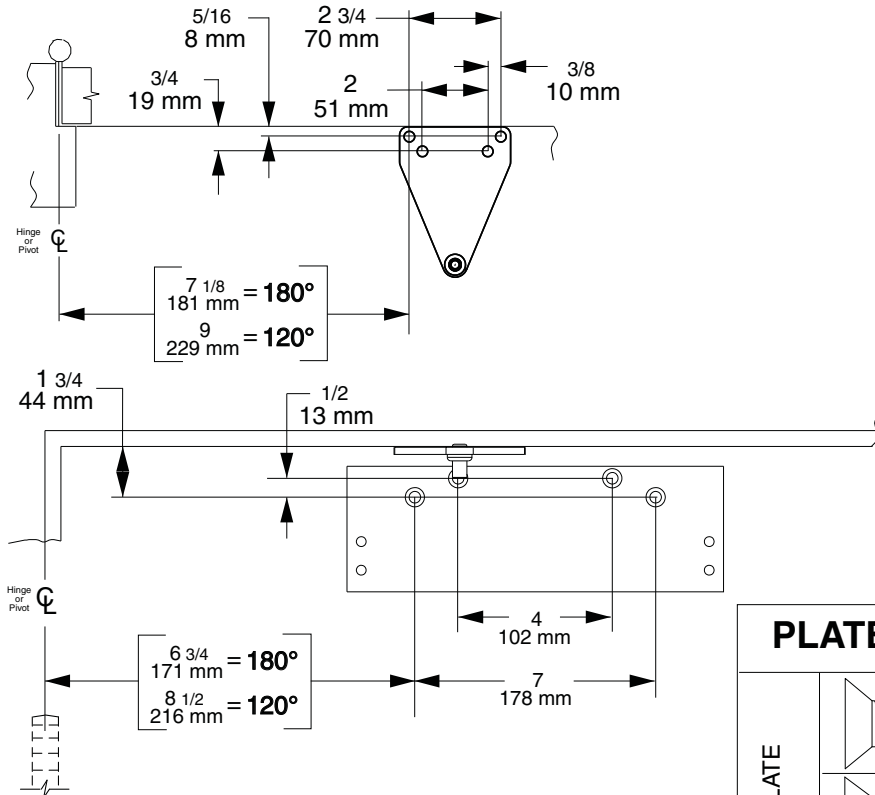

- General Notes:
1. Latch speed faces away the hinge edge.
 2. Use shorter machine screws to attach cylinder to drop plate.

LEFT HAND DOOR ILLUSTRATED. Same dimensions apply for Right Hand Door measured from hinge side.

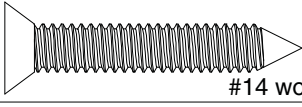
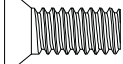
PLATE FASTENERS		DOOR / FRAME	DRILL-SIZES
PLATE		METAL	drill: #7 tap: 1/4-20
	1/4-20 machine		
CLOSER BODY		WOOD	1/8"
	#14 wood		
CLOSER BODY		PLATE	N/A
	1/4-20 machine		

CAUTION
IMPROPER INSTALLATION OR REGULATION MAY RESULT IN PERSONAL INJURY OR PROPERTY DAMAGE. FOLLOW ALL INSTRUCTIONS CAREFULLY. FOR QUESTIONS, CALL Dor-O-Matic AT 1-800-815-1517

DANGER
Une installation ou un réglage inadéquats peuvent entraîner des blessures ou des dommages. Veuillez suivre toutes les instructions avec soin. Pour plus de renseignements, composez le 1-800-815-1517

ADVERTENCIA
Una instalación o un ajuste incorrectos pueden resultar en daño personal o material. Siga bien todas las instrucciones. para más informaciones, llama a Icn al 1-800-815-1517



SC94 Hold-Open PUSH SIDE (TOP JAMB) DROP PLATE PERMITS 180° MAXIMUM OPENING

PUSH SIDE MOUNT ON: SC90-18 DROP PLATE

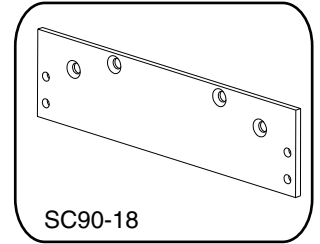
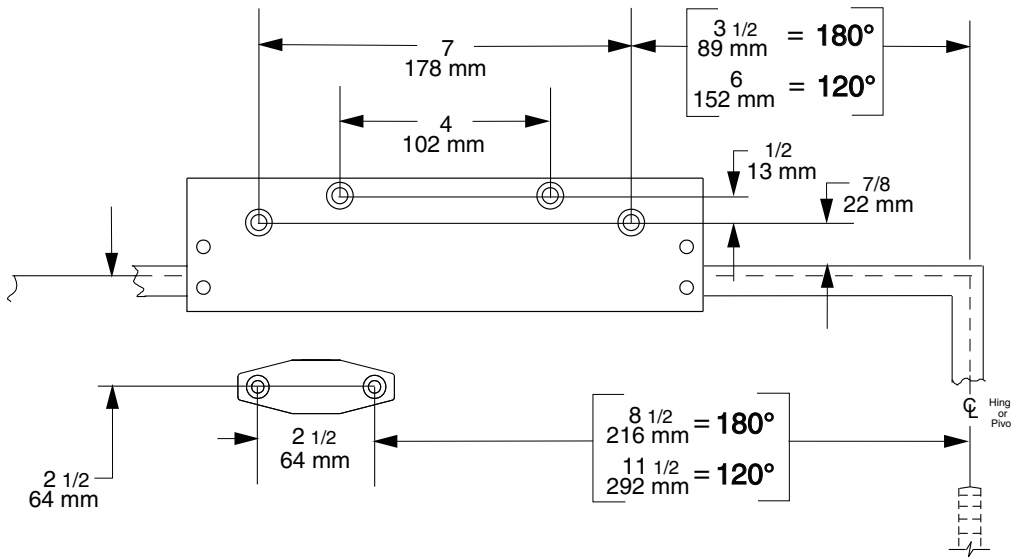

- General Notes:
1. Latch speed faces toward from the hinge edge.
 2. Use shorter machine screws to attach cylinder to drop plate.

RIGHT HAND DOOR ILLUSTRATED. Same dimensions apply for Left Hand Door measured from hinge side.

SC94 Hold-Open PUSH SIDE (PA DOOR MOUNT) DROP PLATE PERMITS 180° MAX. OPENING, BUTT SIZE 5x5 MAX.

PUSH SIDE MOUNT ON: SC90-18PA DROP PLATE

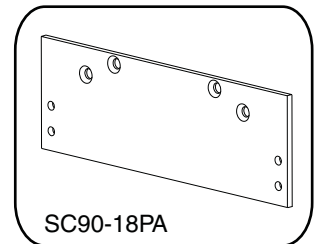
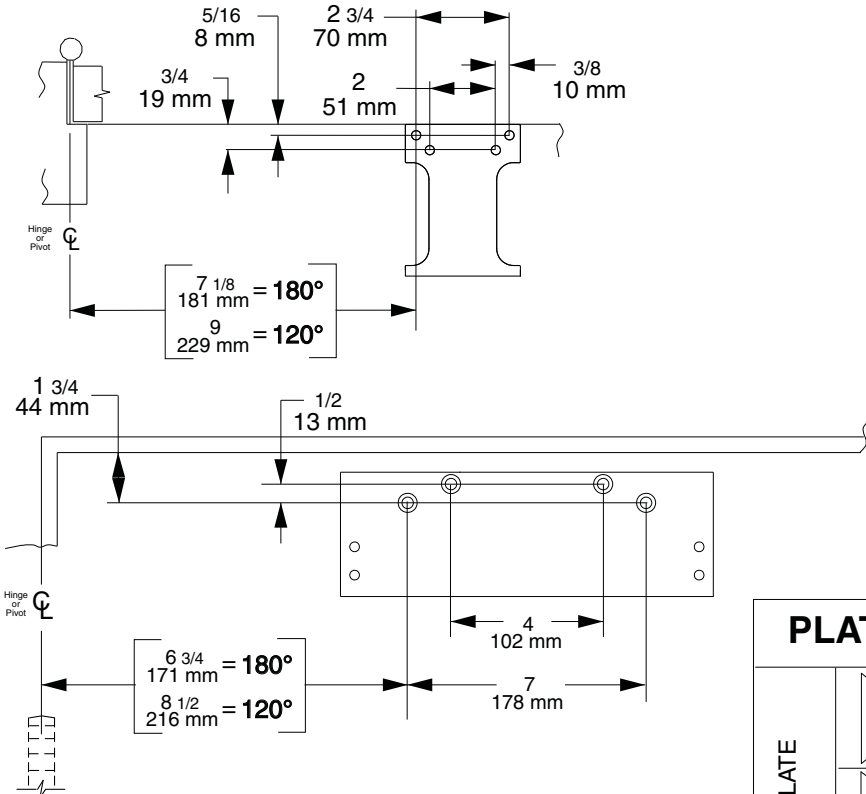

- General Notes:
1. Latch speed faces away the hinge edge.
 2. Use shorter machine screws to attach cylinder to drop plate.

LEFT HAND DOOR ILLUSTRATED. Same dimensions apply for Right Hand Door measured from hinge side.

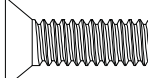
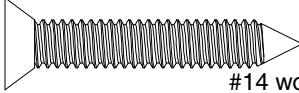
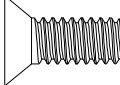
PLATE FASTENERS		DOOR / FRAME	DRILL-SIZES
PLATE		METAL	drill: #7 tap: 1/4-20
		WOOD	1/8"
CLOSER BODY		PLATE	N/A

CAUTION
IMPROPER INSTALLATION OR REGULATION MAY RESULT IN PERSONAL INJURY OR PROPERTY DAMAGE. FOLLOW ALL INSTRUCTIONS CAREFULLY. FOR QUESTIONS, CALL Dor-O-Matic AT 1-800-815-1517

DANGER
Une installation ou un réglage inadéquats peuvent entraîner des blessures ou des dommages. Veuillez suivre toutes les instructions avec soin. Pour plus de renseignements, composez le 1-800-815-1517

ADVERTENCIA
Una instalación o un ajuste incorrectos pueden resultar en daño personal o material. Siga bien todas las instrucciones. para más informaciones, llama a lcn al 1-800-815-1517

